

# EXTRACTION OF EEG SIGNALS FROM POLYSMNOGRAPHIC RECORDS BY APPLYING COMBINED CASCADED ADAPTIVE FILTERS

**JayaLaxmi.Anem<sup>1</sup>, P. Srujana<sup>2</sup>A. Sai Kumar<sup>2</sup>, M. Soni<sup>2</sup>, B. Sarath Kumar<sup>2</sup>,  
K. Rajasekhar<sup>2</sup>,**

<sup>1</sup> **Sr. Assistant Professor, Department of Electronics and Communication Engineering, Aditya Institute of Technology and Management College, Tekkali, Srikakulam, Andhra Pradesh, India, 532201.**

<sup>2</sup>**Student, Department of Electronics and Communication Engineering, Aditya Institute of Technology and Management College, Tekkali, Srikakulam, Andhra Pradesh, India, 532001.**

## ABSTRACT

*Polysomnographic(PSG) is a technique used to diagnose the various sleep disorders. PSG is also called as sleep study. Blood oxygen levels, brain waves, body positions, eye movements, heart rate (ECG) are some of the signals involved in PSG. Especially EEG signals are examined by doctor in order to identify neural oscillations during sleep.*

*Artefacts in EEG records are caused by various factors like Base interference(BE), muscle artefacts (EMG), Electrocardiogram (ECG) and power line noise. These noise sources increase the difficulty in analysing the EEG signals and obtaining original information. For this reason, it is necessary to design specific filters to decrease such artefacts in EEG signals. In this project a combined cascaded LMS & NLMS algorithm is proposed and measure the metrics like SNR, MSE, LSE, MAE.*

**Keywords:** *EEG signal, Artefacts, LMS & NLMS, SNR, MSE, LSE, MAE.*

## 1. INTRODUCTION

“Extraction of EEG signals from polysomnographic records by applying combined cascaded adaptive algorithm” involves the utilization of adaptive filtering algorithm to removal of EEG data from PSG studies.

A diagnostic procedure called polysomnography evaluates physiological aspects of sleep, such as breathing, eye movements, muscle activity, and brain waves (EEG). EEG signals are of special importance since they can be used to identify sleep problems and it is a visual representation of brain electrical activity that is obtained from scalp recordings. EEG signal during recording time, such as eye blink, eye movements, muscle activity, and power line interference. As a result, EEG signals should be processed to remove these noises and obtain efficient EEG features. More standard

methods are now employed to remove artefacts from EEG readings. one of the best method is applying adaptive algorithm like LMS & NLMS algorithms to remove the artefacts.

The objective of this paper is to provide a method for accurately and efficiently separating EEG signals from PSG data for use in clinical settings for the detection and treatment of sleep disorders. The project will have a big impact on diagnosing sleep disorders more accurately, which will help patients receive better care and live better lives.

## 2. ARTEFACTS IN EEG

An electrical signal is indicated as a Artefact which are listed from the scalp, but it is not the part of cerebral origin. Any EEG signal that is unrelated to brain activity is considered an artefact. The artefacts in the EEG

comes from sources like muscles, the eyes, outside noise or electrical noise. There are basically two primary categories of EEG artefacts.

Physiological artefacts and non-physiological artefacts it is also called as external artefacts.

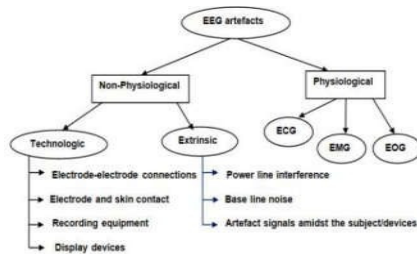

Figure 2.1: Classification of artefacts

An artefact is referred to as a physiological artefact if its source is the subject's body. A source that is outside is referred to as an external artefact.

**3.METHODOLOGY**

It is proposed that a cascading of 4 adaptive filters which are used to remove the artefacts from the EEG signals.

Now the fig 3.1 represents the block diagram of 4 adaptive filters which are in cascaded.

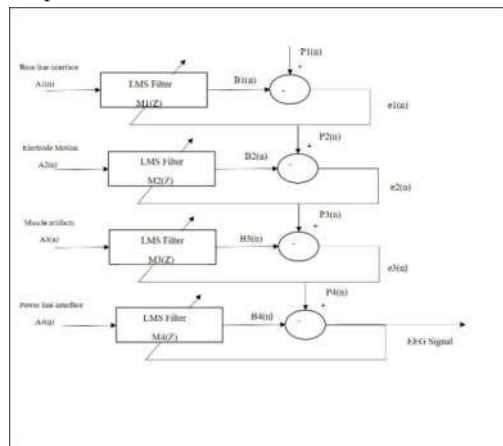

Figure3.1: Block diagram

The block diagram consists of 4 adaptive filters which are cascaded.

**3.1 ADAPTIVE FILTER**

Adaptive filters are a type of digital filter that continuously modifies its filter coefficients to enhance performance. They are frequently employed to eliminate undesirable noise or interference from a signal in signal processing

applications. The fundamental concept underlying adaptive filters is to modify the filter coefficients according to the provided input signal and the desired output signal.

The algorithm modifies the filter coefficients to reduce the contrast between the actual and desired output signals using a mathematical model to assess the relationship within the input and output signals.

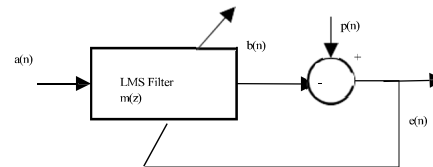

Figure 3.2: Structure of adaptive filter

From the structure of the adaptive filter a(n) represents the reference signal, b(n) represents the output of the LMS filter which is m(z), p(n) represents the corrupted signal, e(n) represents the error signal.

The capacity of adaptive filters to track changes in the input signal over time is one of its key features which is used for the noise cancellation

There are different types of algorithms used in the adaptive filter like LMS algorithm, NLMS algorithm, RLS algorithm.

There are huge number of applications are there for adaptive filters like echo cancellation, system identification, inverse modelling etc.

**3.2 LMS ALGORITHM**

Least Mean Square algorithm is the simple adaptive algorithm. In digital signal processing applications, the least mean squares (LMS) algorithm is a well-liked adaptive algorithm for modifying the coefficients of a digital filter. The LMS algorithm adjusts the filter coefficients based on the error between the filter output and the desired output. It is a stochastic gradient descent process.

$$e(n)=p(n)-b(n)..... (1)$$

where p(n) represents the desired output and b(n) is the filter output

The LMS method operates by gradually changing the filter coefficients in the direction of the negative gradient of the error

The weight updated equation of the LMS algorithm is given by

$$w(n+1)=w(n)+2*\mu. a(n) * e(n)..... (2)$$

where w(n) is the vector of filter coefficients at time n, μ is the step size or, e(n) is the error at time n, and a(n) is the input signal at time n.

The rate of convergence of the LMS algorithm is determined by the important parameter called step size.

**3.3 NLMS ALGORITHM**

Normalized Least Mean Square (NLMS) algorithm is one of the adaptive filtering algorithm. There are some disadvantages in the LMS algorithm that is fixed step size for every iteration and there is no limit for the LMS algorithm to overcome the difficulty NLMS algorithm is developed.

In the NLMS algorithm the step size is normalized. The extension version of the LMS algorithm is the NLMS algorithm in which maximum step size is calculated.

$$\mu(n) = \frac{\beta}{|a(n)|^2} \dots \dots \dots (3)$$

Where  $\beta$  is the normalized step size ( $0 < \beta < 2$ )

Then the weight updated equation of the LMS filter is varied to the

$$w_i(n+1) = w_i(n) + \frac{\beta}{|a(n)|^2} e(n)x(n-k) \dots (4)$$

According to the figure 3.1 there are Four adaptive filters which are cascaded.

In the first stage,  $a_1(n)$  is the first reference signal i.e., Base line which is given to the first LMS filter i.e.,  $m_1(z)$ . The filter produces the output as  $b_1(z)$  which is the estimation of base line present in the EEG.  $p_1(n)$  is the input signal which is corrupted with different artefacts like EEG, base line interference, electrode motion, EMG and the power line interface.

$$e_1(n) = p_1(n) - b_1(n)$$

now the  $e_1(n)$  signal consists of all signals except the base line interference. Now the  $e_1(n)$  is given to corrupted signal  $p_2(n)$  to the second stage.

In the second stage,  $a_2(n)$  is the second reference signal i.e., electrode motion which is given to the second LMS filter i.e.,  $m_2(z)$ . The filter produces the output as  $b_2(z)$  which is the estimation of artefacts of electrode motion present in the EEG.  $p_2(n)$  is the input signal which is corrupted with different artefacts like EEG, electrode motion, EMG and the power line interface.

$$e_2(n) = p_2(n) - b_2(n)$$

now the  $e_2(n)$  signal consists of all signals except the electrode motion. Now the  $e_2(n)$  is given to corrupted signal  $p_3(n)$  to the third stage

In the third stage  $a_3(n)$  is the third reference signal i.e., EMG(Muscle) artefacts which is given to the third LMS filter i.e.,  $m_3(z)$ . the filter produces the output as  $b_3(z)$  which is the estimation of artefacts of EMG present in the EEG.  $p_3(n)$  is the input signal which is corrupted with different artefacts like EEG, EMG and the power line interface.

$$e_3(n) = p_3(n) - b_3(n)$$

now the  $e_3(n)$  signal consists of all signals except the muscle artefacts. Now the  $e_3(n)$  is given to corrupted signal  $p_4(n)$  to the fourth stage.

In the fourth stage,  $a_4(n)$  is the fourth reference signal i.e., power line interference which is given to the fourth LMS filter i.e.,  $m_4(z)$ . The filter produces the output as  $b_4(z)$  which is the estimation of power line interface present in the EEG.  $p_4(n)$  is the input signal which is corrupted with different artefacts like EEG, the power line interface.

$$e_4(n) = p_4(n) - b_4(n)$$

It is the final output of the adaptive filter which produces the clean EEG signal without any noise. The data base is collected from the MIT – BIH Polysomnographic physio bank.

**4. SIMULATION AND RESULTS**

The simulation results are obtained in MATLAB and also computed fidelity parameters like Signal to Noise Ratio (SNR), Mean Square Error (MSE), Mean Average Error(MAE), Least Square Error(LSE) with LMS & NLMS algorithm.

Wave forms for LMS algorithm

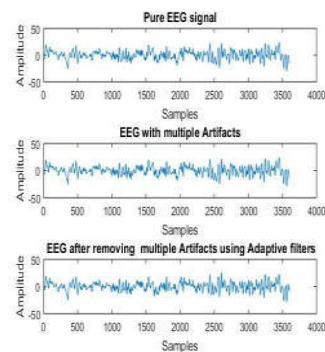

Figure 4.1: Results of pure EEG signals using LMS algorithm

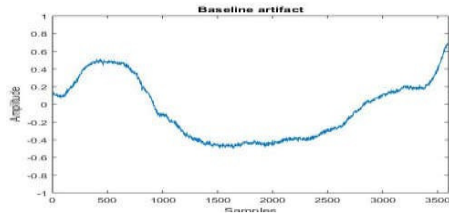

Figure 4.2 :Base line artefact

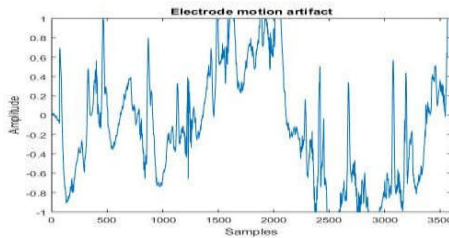

Figure 4.3: Electrode motion artefact

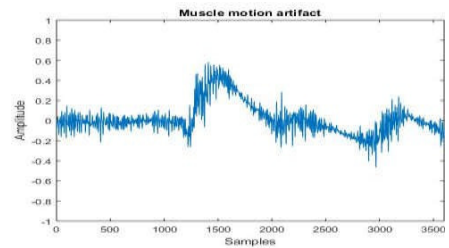

Figure 4.4: Muscle motion artefact

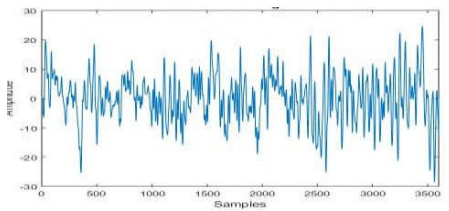

Figure 4.5: Noised EEG after removing baseline artefact

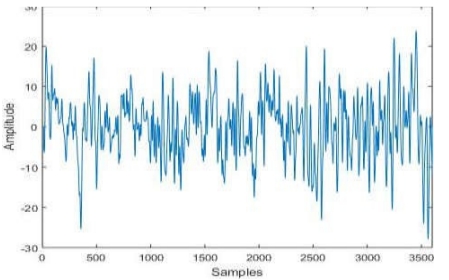

Figure 4.6: Noised EEG after removing baseline noise and electrode motion

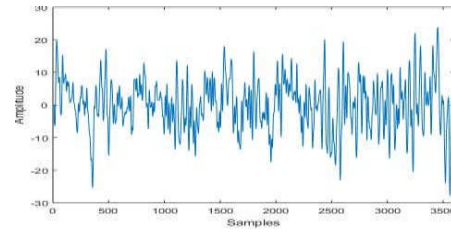

Figure 4.7: Noised EEG after removing baseline noise, electrode motion and EMG artefacts

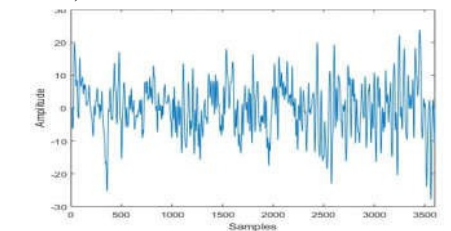

Figure 4.8: Pure EEG signal after removing all artefacts

s.no	Step size	Input SNR	Output SNR	LSE	MAE	MSE
1	0.001	20.9097	93.1963	4.3506e-4	2.3945e-07	2.9780e-08
2	0.002	20.9097	86.8770	8.8114e-4	4.7515e-07	1.2231e-07
3	0.003	20.9097	83.1359	0.0013	6.9368e-07	2.7824e-07
4	0.004	20.9097	80.4351	0.0018	8.9128e-07	4.9853e-07
5	0.005	20.9097	78.2925	0.0023	1.0705e-07	7.8615e-07

Table 4.1: Error parameters using LMS algorithm

Wave forms for NLMS algorithm

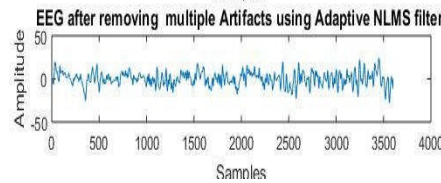
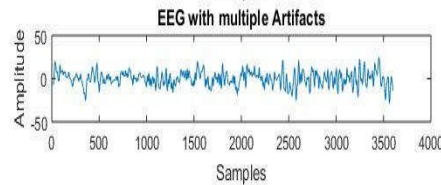
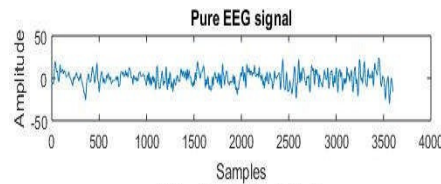

Figure 4.9: Results of pure EEG signals using NLMS algorithm

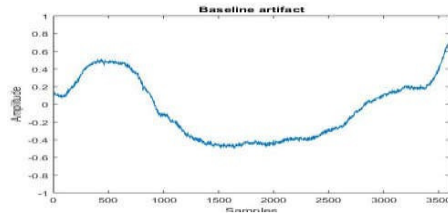

Figure 4.10: Base line artefact

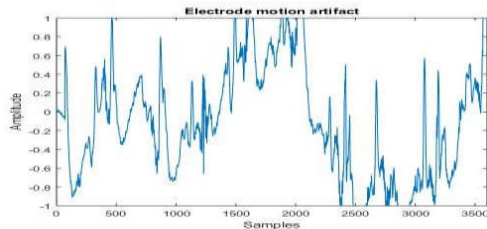

Figure 4.11: Electrode motion artefact

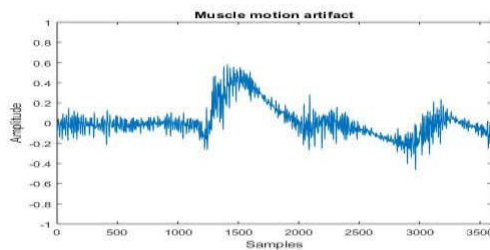

Figure 4.12: Muscle motion artefact

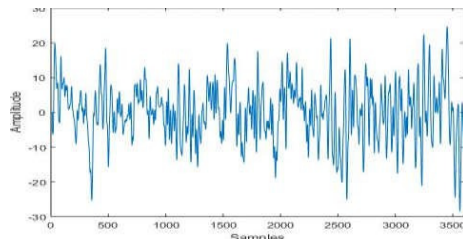

Figure 4.13: Noised EEG after removing baseline artefact

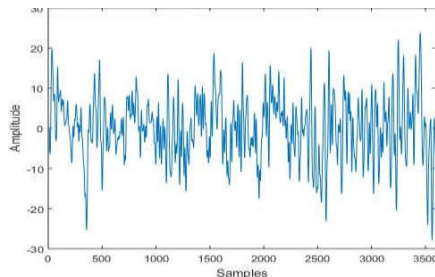

Figure 4.14: Noised EEG after removing baseline noise and electrode motion

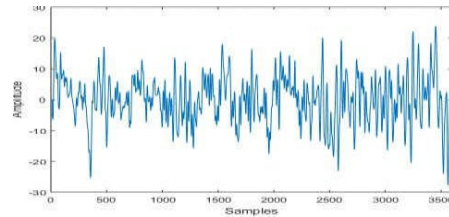

Figure 4.15: Noised EEG after removing baseline noise, electrode motion and EMG artefacts

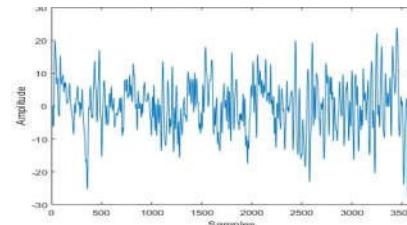

Figure 4.16: Pure EEG signal after removing all artefacts

s.no	Step size	Input SNR	Output SNR	LSE	MAE	MSE
1	0.001	20.9097	100.1904	4.0878e-4	3.1778e-09	5.6244e-09
2	0.002	20.9097	94.1679	8.0058e-4	7.1838e-08	2.0646e-08
3	0.003	20.9097	90.6443	0.0012	1.2024e-07	4.2966e-08
4	0.004	20.9097	88.1441	0.0015	1.7937e-07	7.1124e-08
5	0.005	20.9097	86.2047	0.0018	2.5242e-07	1.0408e-07

Table 4.2: Error parameters using NLMS algorithm

## 5. CONCLUSION

The implementation of LMS & NLMS algorithms of Adaptive filter on noised EEG signal was performed. The noised EEG signals is applied to combined cascaded Adaptive filter and obtained pure EEG signals. The responses of LMS algorithm based adaptive filter are shown in the figure from 4.1 to 4.8 and the responses of NLMS algorithm based Adaptive filter are shown in the figure from 4.9 to 4.16. The fidelity parameters like SNR, MSE, LSE, MAE are calculated and compared between the LMS & NLMS algorithm. From the table 4.1 and 4.2 we get that step size 0.001 is the best step size because the step sizes from 0.002 to 0.005 SNR ratio decreases and LSE, MAE, MSE are increases so, 0.001 is best step size. The output SNR is increased in table 4.2 as

compared to the table 4.1. So from the above discussions it is concluded that NLMS algorithm produces better responses in terms of SNR, MSE, MAE, LSE.

#### REFERENCES

[1]. Akhtar, M.T.; James, C.J & Mitsuhashi W. (2010). Modifying the Spatially-Constrained ICA for Efficient Removal of Artefacts from EEG Data. Proceedings of 4th International Conference on Bioinformatics and Biomedical Engineering (ICBBE), pp. 1-4. ISBN: 978-1-4244-4713-8, Chengdu, China, June 18-20, 2010.

[2]. He P, Wilson G, Russel C: Removal of artefacts from electro-encephalogram by adaptive filtering. Medical & biological engineering & computing 2004; 42(3): 407-12.

[3] Garcés Correa, A.; Laciár, E.; Patiño, H.D. & Valentinuzzi, M.E. (2007). Artefact removal from EEG signals using adaptive filters in cascade, Journal of Physics, Vol.90, (September 2007), pp.1-10.

#### About the Author

Jayalaxmi. Anem is currently working as a Sr. Assistant Professor in the Department of Electronics and Communication Engineering at Aditya Institute of Technology and Management, A.P., India. She had obtained her Bachelor's Degree under AU, and M. Tech in VLSI System Design under JNTU, Kakinada. Her research areas of interest, includes Digital Signal Processing, Biomedical Signal, and Image Processing.



[4]. Reddy, A.G., & Narava, S.(2013). Artefact removal from EEG signals, International journal of computer Applications,77(13)

[5] R. H. Kwong, and E. W. Johnston "A Variable Step Size LMS Algorithm", *IEEE Trans. Signal Processing*, vol. 40, no. 7, pp. 1633–1642, 1992.

[6] A.K. Verma, N. Verma, "A Comparative Performance Analysis of Wavelets in Denoising of Speech Signals," National Conference of Advancement of Technologies – Information Systems & Computer Networks (ISCON), 2012.

[7] G. Yadav and B. Krishna, "Study of different adaptive filter algorithms for noise cancellation in real-Time environment". International Journal of Computer Applications, January 2014